

# Use of Zoom for large class teaching: My experience

by

Hiran H E Jayaweera

hiran@phys.cmb.ac.lk



5<sup>th</sup> Training Program by Blended Learning Project of the University of Colombo

# Today's session



How I managed get students involved in the discussion



How I did collaborative teaching with colleague



Annotation and whiteboard

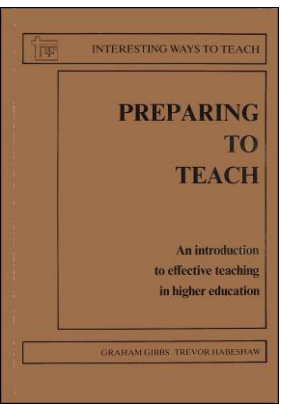
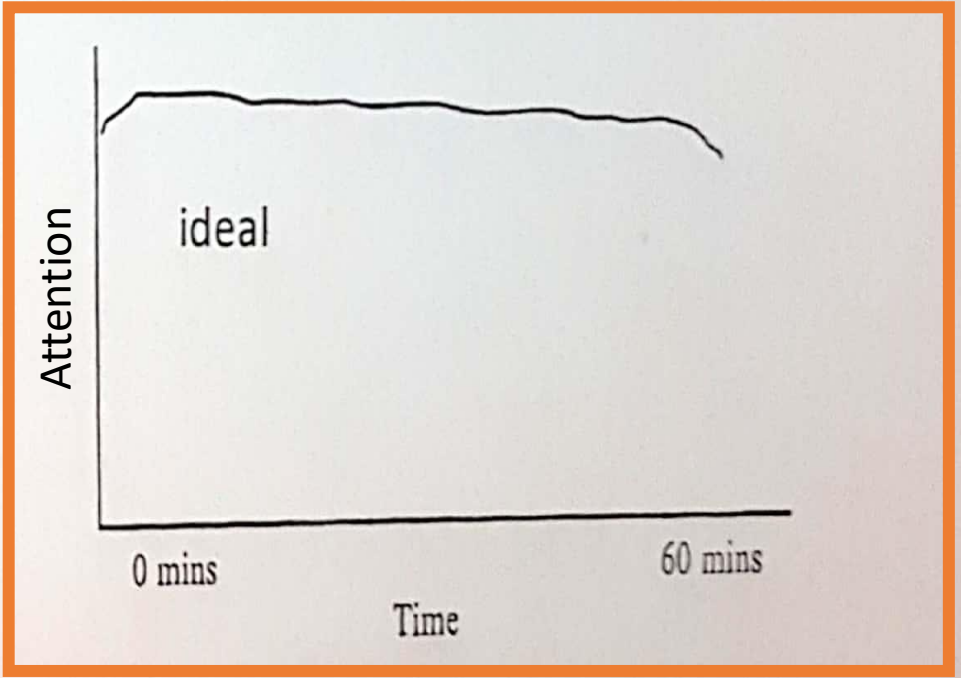
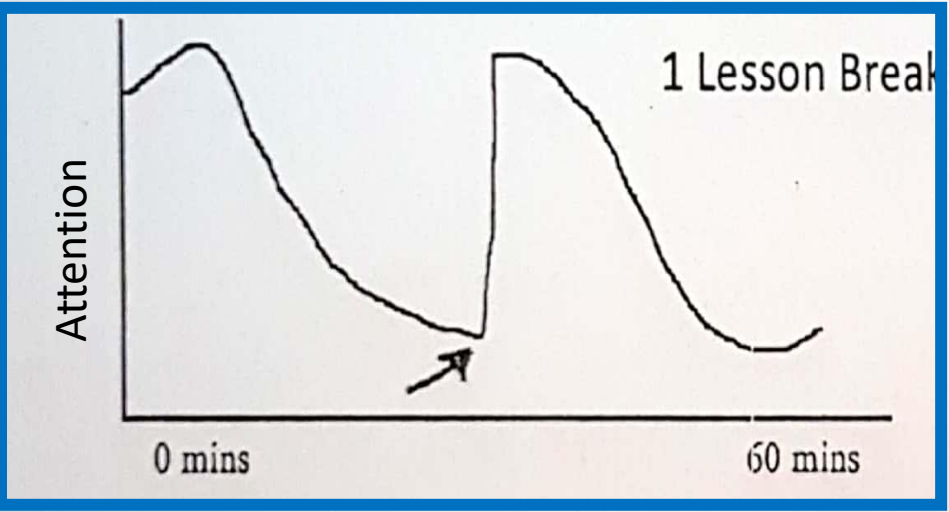

Gibbs, G. and Habeshaw, T. (2001). *Preparing to teach*. Bristol: Technical and Educational Services.

The screenshot displays a Zoom meeting interface with a shared screen. The screen shows three graphs illustrating attention levels over a 60-minute period. The top graph shows a steady decline in attention. The middle graph shows a dip in attention during a '1 Lesson Break', with an arrow pointing to the start of the break. The right graph, highlighted with an orange border, shows a high and stable attention level labeled 'ideal'. A 'Reactions' menu is open at the bottom right, featuring a 'Raise Hand' button and navigation controls. A red arrow points to the 'Reactions' button in the Zoom toolbar.

Click to join audio

Attention

0 mins 60 mins

1 Lesson Break

Attention

0 mins 60 mins

Attention

0 mins 60 mins

ideal

60 mins

60 mins

Reactions

Join Audio Stop Video Participants Chat Share Screen Record Reactions Leave

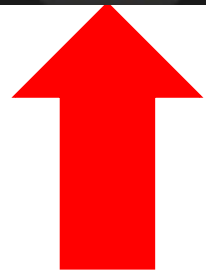

# What colour is it?



1. white and gold → click Yes 
2. black and blue → click No 

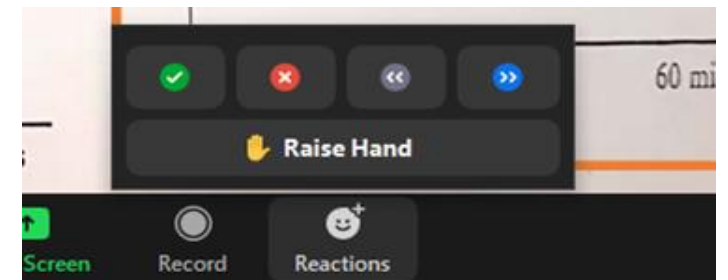

Participants (39)

Find a participant

- Hiran E Jayaweera (Host, me)
- Hiran E Jayaweera (Co-host)
- Migara Jayasinghe (Co-host)
- Thevikum Edirisinghe (Co-host)
- Aloka Seneviratne - s14376
- Anujitha s14341
- Bhathiya- S14309
- Chanakya\_s14349
- chandeepa\_s14369
- Chani\_s14356
- Chathuranga s14424
- Dinuka Ganganath
- Dulmini-s14367
- dumidu-s14307
- Dushmanthi s14358

19 yes 2 no go slower go faster more clear all

Invite Mute All ...

# Participants list

Dushmanthi s14358

19 yes 2 no go slower go faster more clear all

Invite Mute All ...



Look at your monitor through the slit in between pointer and middle finger

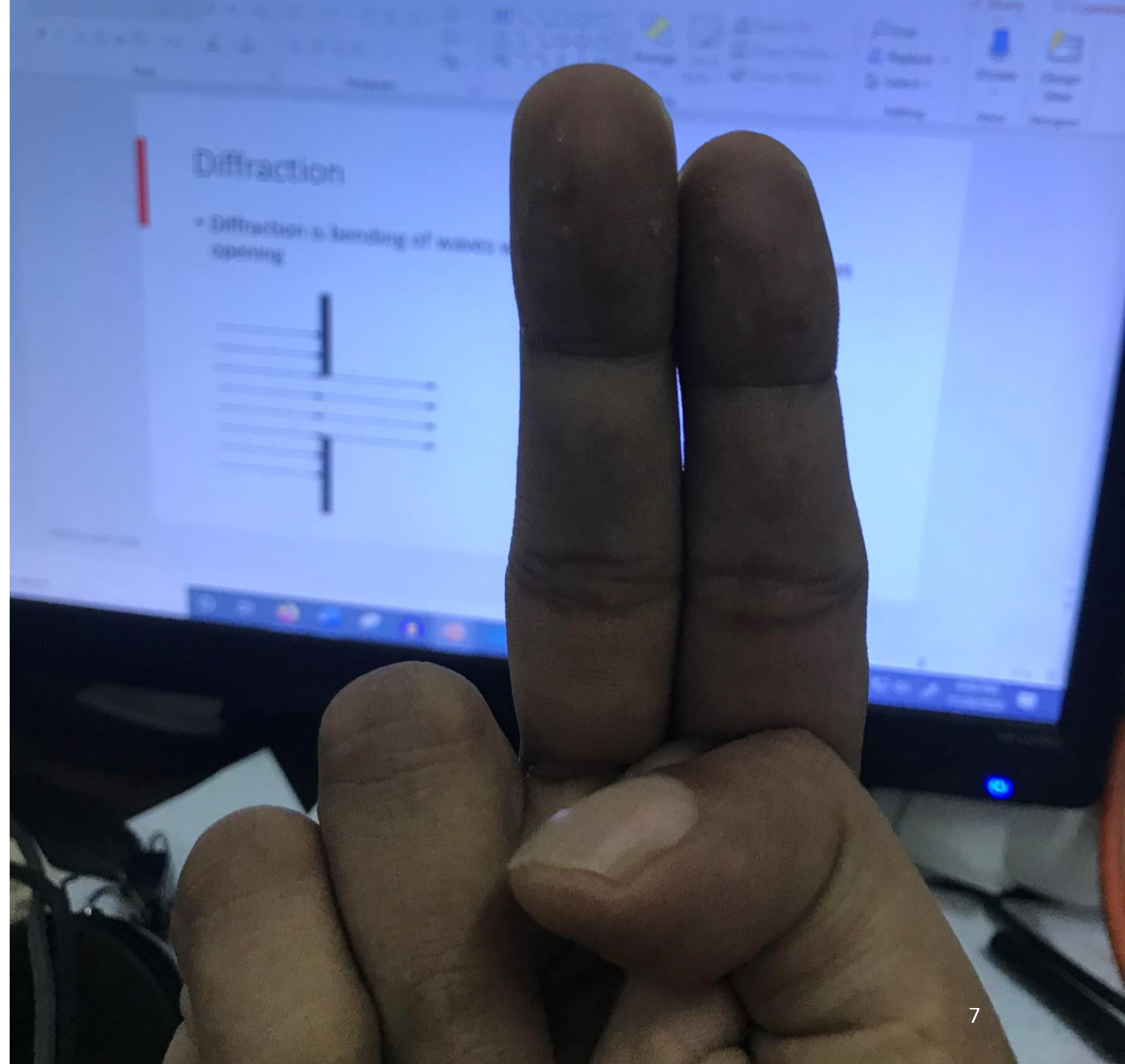

# What colour is it?



1. white and gold → click Yes 
2. black and blue → click No 

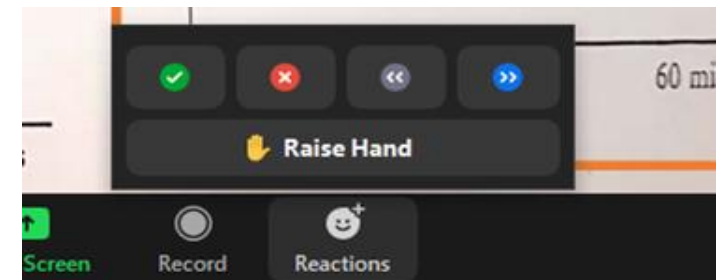



**zoom** Video Conferencing

Join

Connect to a meeting in progress

Our system may be busy sometimes during the office hours, Please try your best to **avoid scheduling meetings/lectures to start in red zones**

How to  
configure  
Zoom

[learn.zoom.lk](https://learn.zoom.lk)

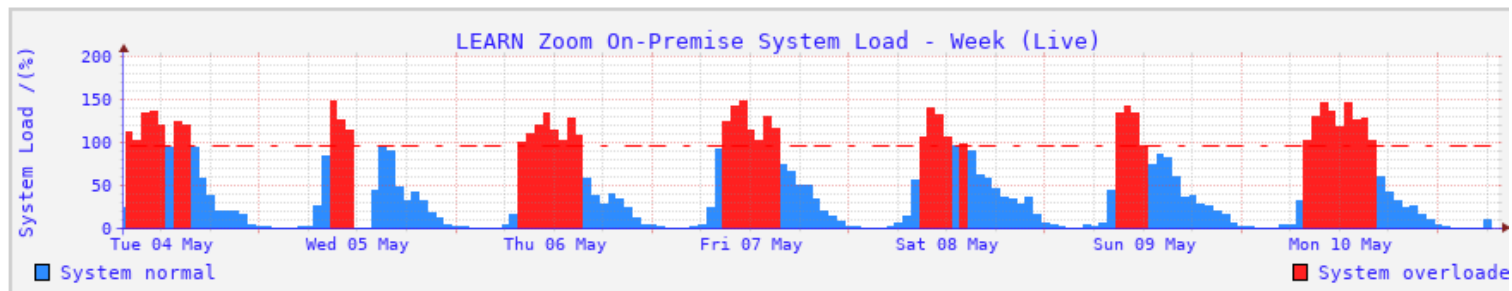
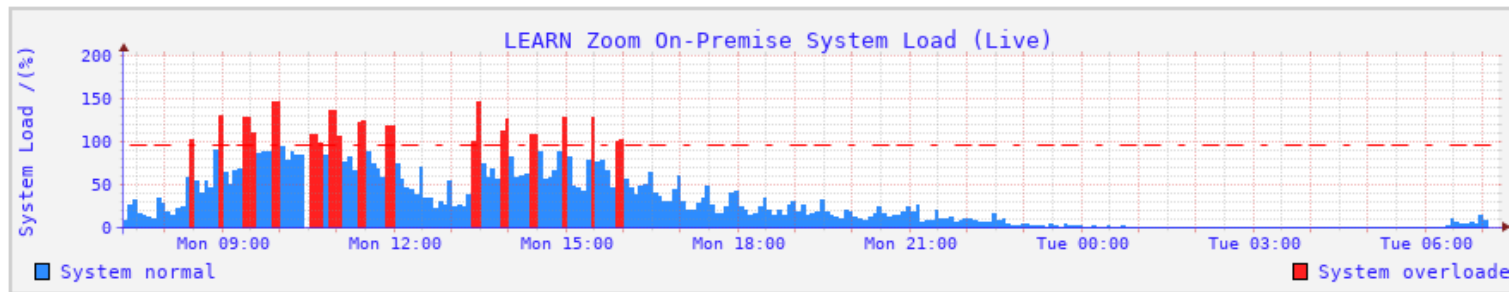

Host

Start a meeting

Sign in

Configure your account



# Settings → In Meeting (basic)

Profile

Meetings

Webinars

Recordings

Settings

Account Profile

Reports

[Attend Live Training](#)

[Video Tutorials](#)

[Knowledge Base](#)

Meeting

Recording

Telephone

Collaboration Devices

Security

Schedule Meeting

In Meeting (Basic)

In Meeting (Advanced)

Email Notification

Other

Security

## Require that all meetings are secured with one security option

Require that all meetings are secured with one of the following security options: a passcode, Waiting Room, or "Only authenticated users can join meetings". If no security option is enabled, Zoom will secure all meetings with a Waiting Room. [Learn more](#) 

## Waiting Room

When participants join a meeting, place them in a waiting room and require the host to admit them individually. Enabling the waiting room automatically disables the setting for allowing participants to join before host.

## Waiting Room Options

The options you select here apply to meetings hosted by users who turned 'Waiting Room' on.

✓ Everyone will go in the waiting room

[Edit Options](#) [Customize Waiting Room](#)

# Enable non-verbal feedback

## Disable meeting reactions

In Meeting (Basic)

Auto save whiteboard content when sharing is stopped 

In Meeting (Advanced)

Email Notification

Other

### Remote control

During screen sharing, the person who is sharing can allow others to control the shared content

Allow remote controlling user to share clipboard 



### Non-verbal feedback

Allow meeting participants to communicate without interrupting by clicking on icons (yes, no, slow down, speed up). These icons are found in the Reactions menu in the toolbar, and when selected, they display on the participant's video and in the participants list until dismissed. 



### Meeting reactions

Allow meeting participants to communicate without interrupting by reaction with emojis (e.g. clap, heart, laugh). These emojis are found in the Reactions menu in the toolbar, and when selected, they display on the participant's video and in the participants list for 10 seconds. Participants can change their emoji skin tone in Settings. 





Dushmanthi s14358



19



yes

2



no



go slower



go faster



more

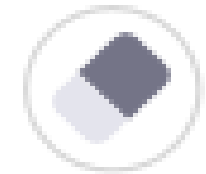

clear all

Invite

Mute All

...

# Hardware setup

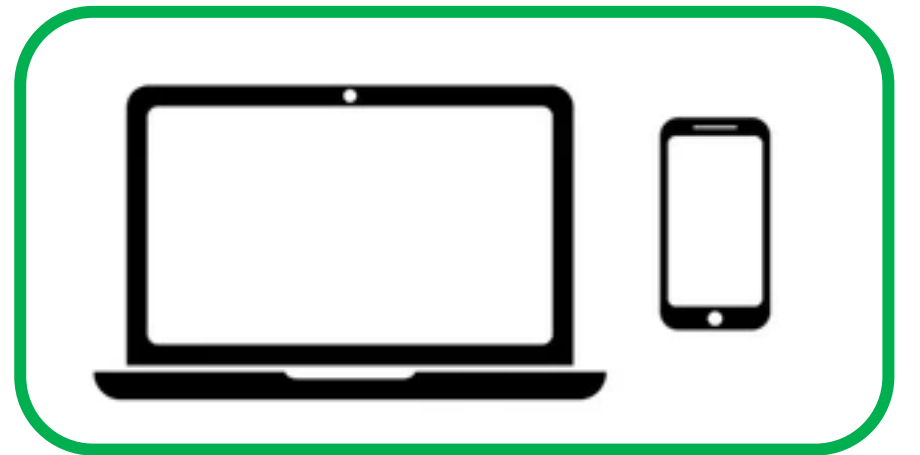
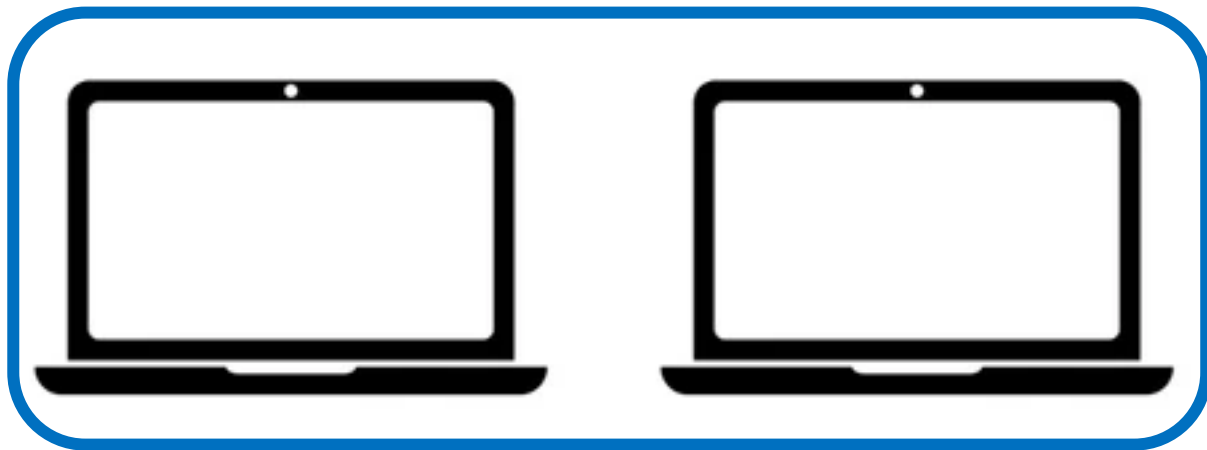
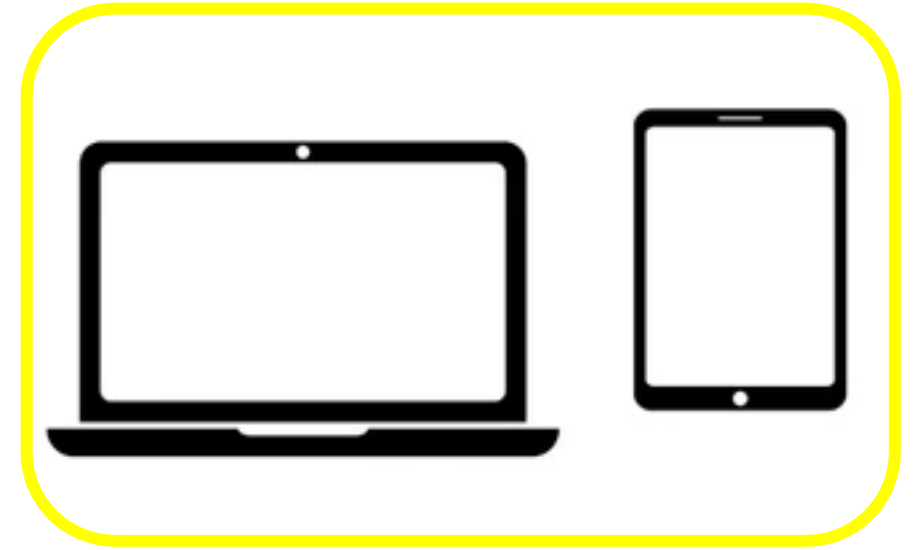
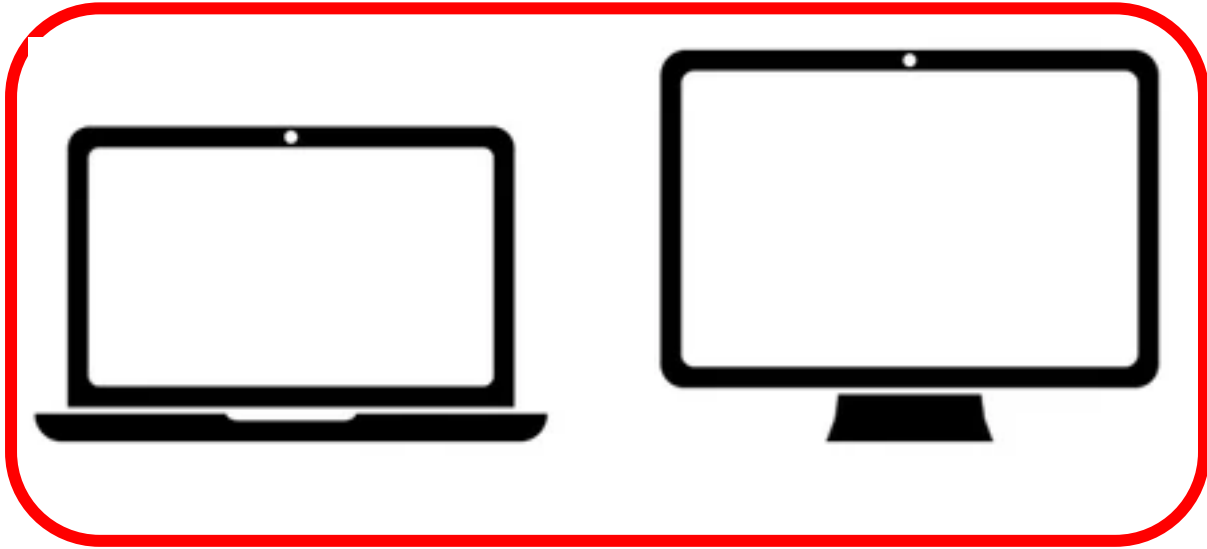

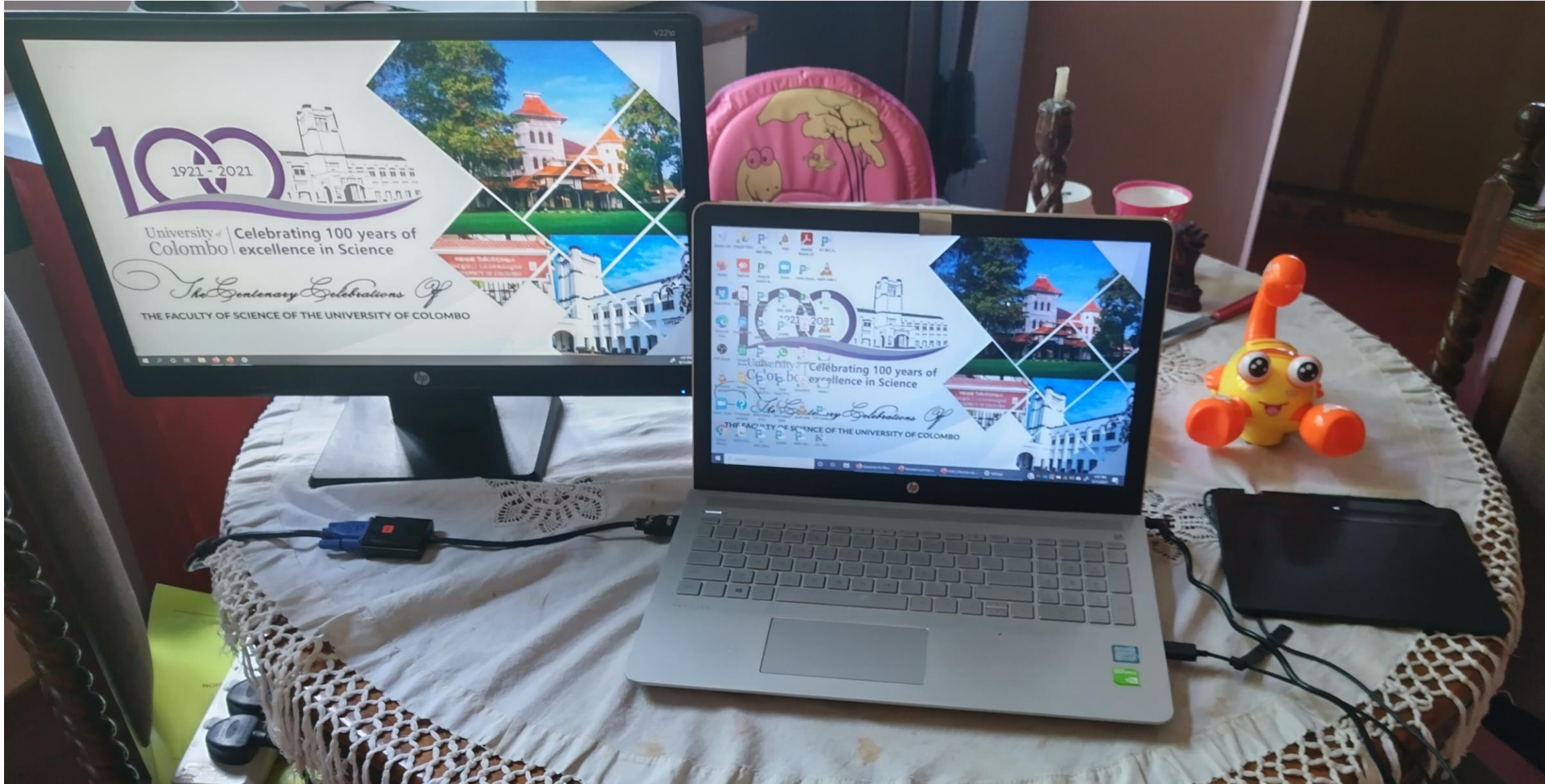



# Secondary zoom session

**MICROCHIP**

**megaAVR**

## Introduction

The ATmega32A is a low power, CMOS 8-bit micro architecture. The ATmega32A is a 40/44-pins device w cutting instructions in a single clock cycle, the de instructions per second (MIPS) per megahertz, a tion versus processing speed.

## Features

- High-performance, Low-power AVR<sup>®</sup> 8-bit Micro
- Advanced RISC Architecture
  - 131 Powerful Instructions – Most Single-clo
  - 32 × 8 General Purpose Working Registers
  - Fully Static Operation
  - Up to 16MIPS Throughput at 16MHz

FET



TT

Chat

space that can store data

From Chani\_s14356 to Everyone: 08:37 AM

A bit is a binary digit, the smallest increment of data on a computer

From s14297 - Dinura Rajith to Everyone: 08:37 AM

measuring unit for a quantity

From viranga\_s14421 to Everyone: 08:37 AM

lowest storage value of Data or information

From s14359 \_ Nisal to Everyone: 08:37 AM

the smallest increment of data on a computer

From Eshan\_ s14394 to Everyone: 08:37 AM

lowest memory capacity unit

From dumidu-s14307 to Everyone:

short for binary digit.is the smallest unit of measurement used to quantify computer data. It contains a single binary value of 0 or 1.

To: s14409 vish... (Direct Message) File

Type message here...

Participants (38)

Find a participant

- Hiran E Jayaweera (Host, me)
- Hiran E Jayaweera (Co-host)
- Migara Jayasinghe (Co-host)
- Thevikum Edirisinghe (Co-host)
- Aloka Seneviratne - S14376
- Anujitha s14341
- Bhathiya- S14309
- Chanakya\_s14349
- Chani\_s14356
- Chathuranga s14424
- Dinuka - s13833
- Dulmini-s14367
- dumidu-s14307
- Dushmanthi\_s14358
- Eshan\_ s14394

3

yes no go slower go faster more clear all

Invite Mute All

## Collaborative teaching with colleague

- Make your colleagues co-hosts and provide all privileges
- Distribute some responsibilities like recording, monitoring the chat window, annotate the screen
- Use breakout rooms for supporting individuals
- Use student teachers

Participants (38)

Find a participant

Name	Role	Video	Audio	Chat
Hiran E Jayaweera	Host, me	Off	Off	Off
Hiran E Jayaweera	Co-host	On	Off	Off
Migara Jayasinghe	Co-host	Off	Off	Off
Thevikum Edirisinghe	Co-host	Off	Off	Off
Aloka Seneviratne	Participant	On	Off	Off
Anujitha s14341	Participant	Off	Off	Off
Bhathiya- S14309	Participant	Off	Off	Off
Chanakya_s14349	Participant	Off	Off	Off
Chani_s14356	Participant	Off	Off	Off



Chat

From Poornika\_s14405 to Everyone:

1771.42nm

From Imesh-s14345 to Everyone:

1771.4nm

From Pamoda-s14402 to Everyone:

1771.42 nm

To: s14409 vish... (Direct Message) File ...

Type message here...

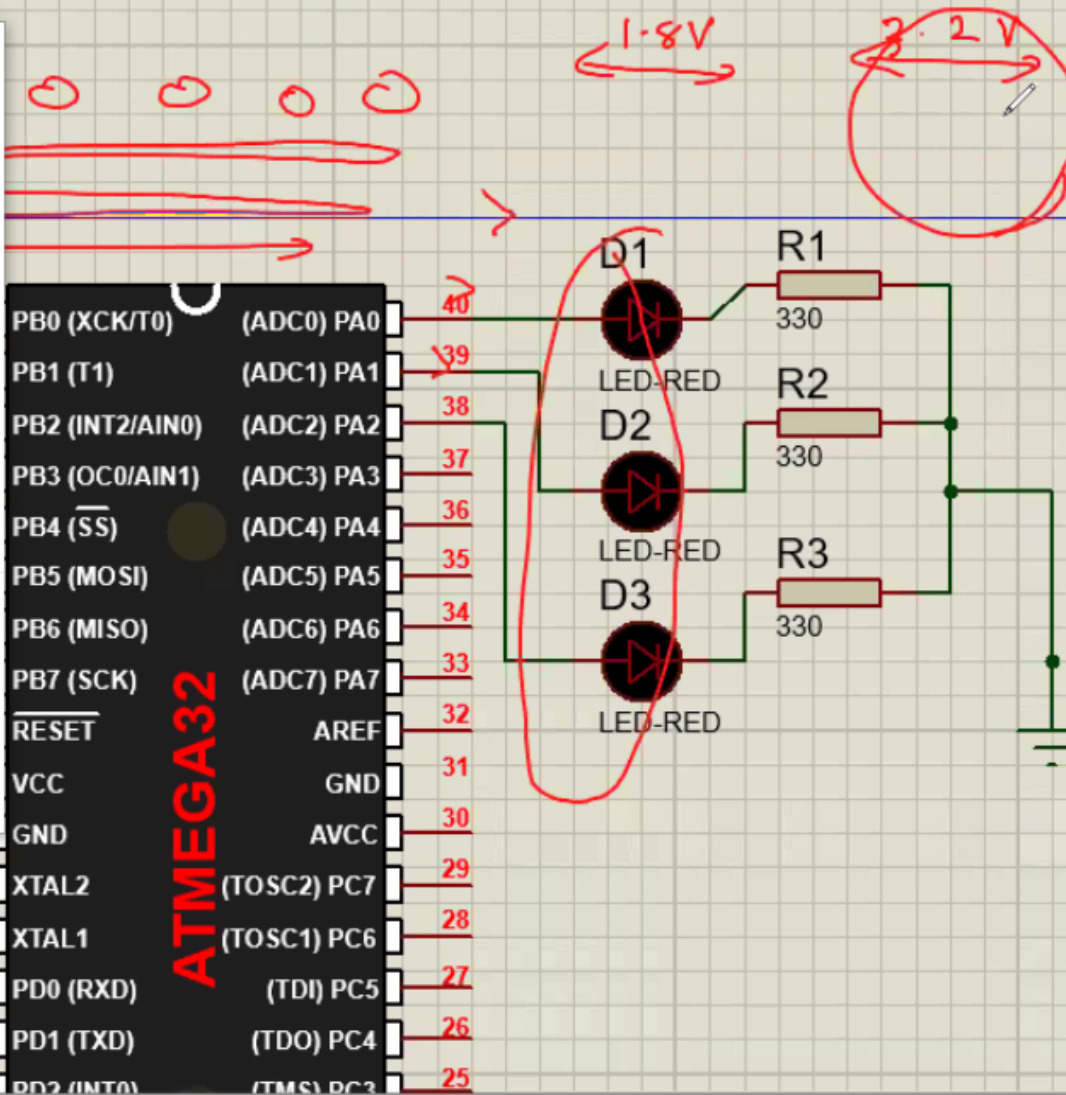

Handwritten calculations:

$$\frac{330\Omega}{680\Omega} \quad 20\text{mA}$$

$$V = IR$$

$$\frac{V}{R} = I$$

$$\frac{3.2}{R} < 20 \times 10^{-3} \text{ A}$$

$$\frac{3.2}{20 \times 10^{-3}} < R$$

# Enable co-host

In Meeting (Basic)

In Meeting (Advanced)

Email Notification

Other

## Display end-of-meeting experience feedback survey

Display a thumbs up/down survey at the end of each meeting. If participants respond with thumbs down, they can provide additional information about what went wrong. 

- Display for every meeting
- Display for meetings randomly

## Co-host

Allow the host to add co-hosts. Co-hosts have the same in-meeting controls as the host.







# How to use annotation and whiteboard

## Pen tablets



## Pen displays



Phones with stylus



iPad with apple pencil

## Convertibles with stylus





# Other tools



# Pen tablets

- Small form factor
- Cheap
- Needs a bit of time to get familiar
- **Wacom Intuos S**
- **Huion**





HUIION  
HUIION Flagship Store

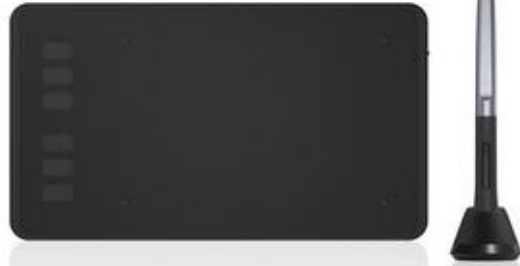

DarazMall

Huion HS611 Graphics Drawing Pen Tablet Tilt 8 Multimedia Keys 10...

Rs. 15,999

FREE

★★★★★(57)

China

DarazMall

Huion H640P Graphics Tablet/Board Drawing Pen Tablet Battery free...

Rs. 8,999

Rs. 12,990 -31% FREE

★★★★★(75)

China

DarazMall

Huion HS610 Graphics Drawing Painting Pen Tablet 8192 10 x 6.25"...

Rs. 12,999

FREE

★★★★★(69)

China

DarazMall

Huion H430P Graphic Drawing Pen Tablet Battery-free Stylus 4096 4...

Rs. 6,999

Rs. 9,990 -30% FREE

★★★★★(40)

China



H430P



Message

Mute Start Video Security Participants 2 New Share Pause Share Annotate Remote Control More

You are screen sharing Stop Share

Mouse Select Text Draw Stamp Spotlight Eraser Format Undo Redo Clear Save

~ / □ ○  
~ ✎ 📊 🌐  
◇ ↗ ▭ ●

Clear All Drawings  
Clear My Drawings  
Clear Viewers' Drawings

Mouse Select Text Draw Stamp Spotlight Eraser Format Undo Redo Clear Save

➡ ✓ ✕  
★ ♥ ?



Basic

Advanced

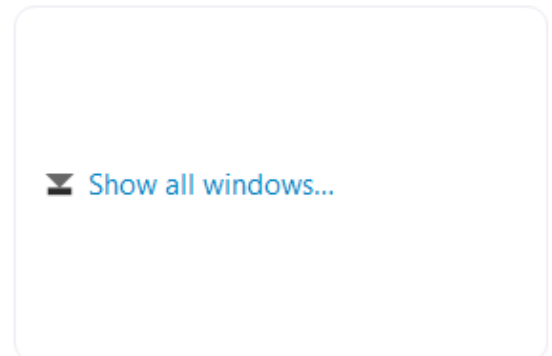
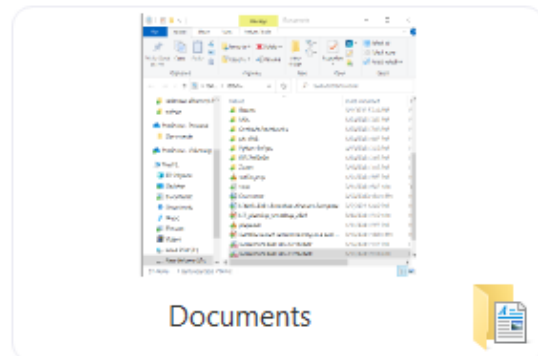
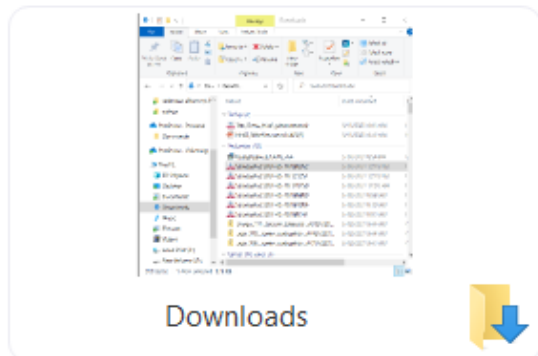
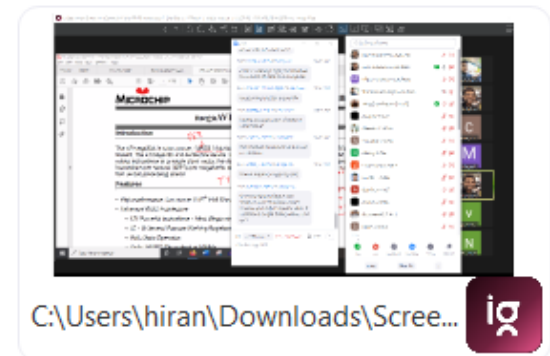
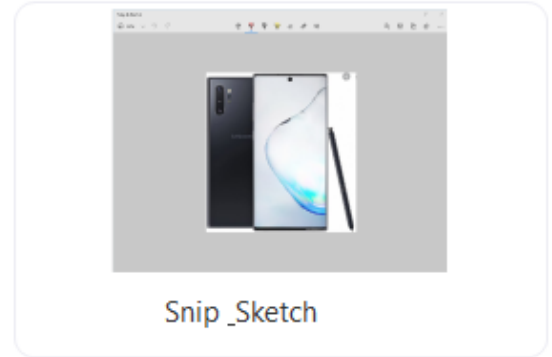
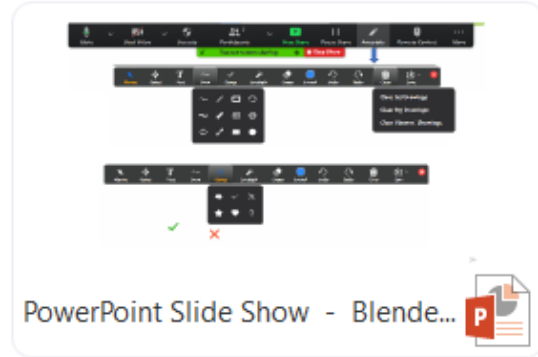
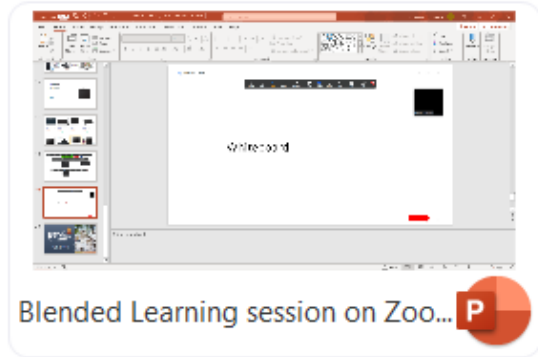
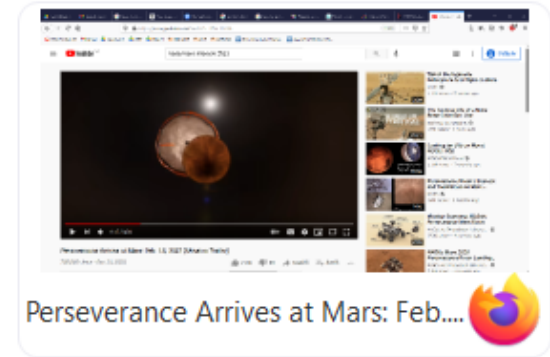
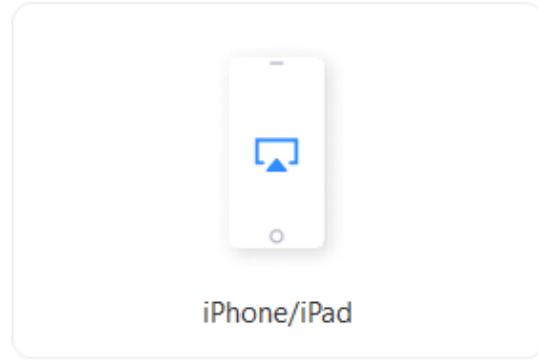
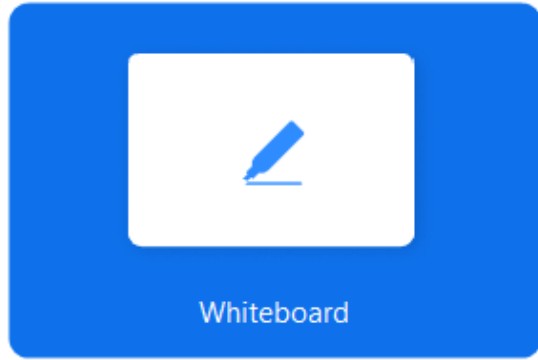
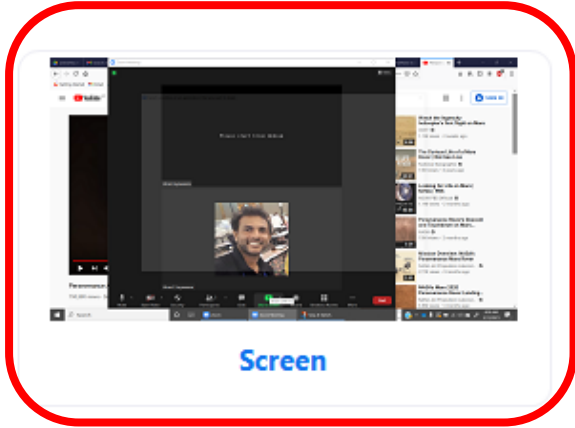

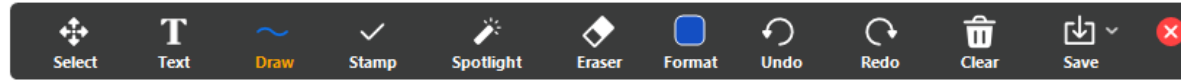

# Whiteboard





# Alternative

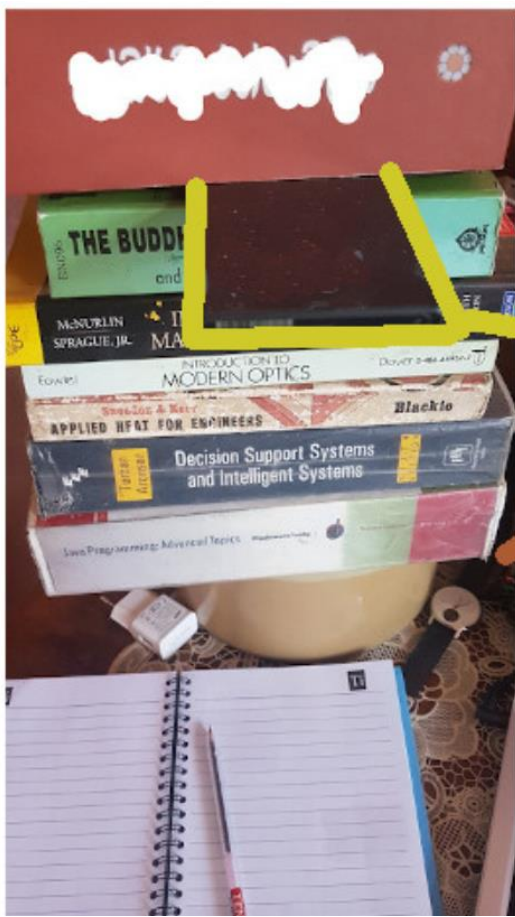

**Phone**  
**Book stack**

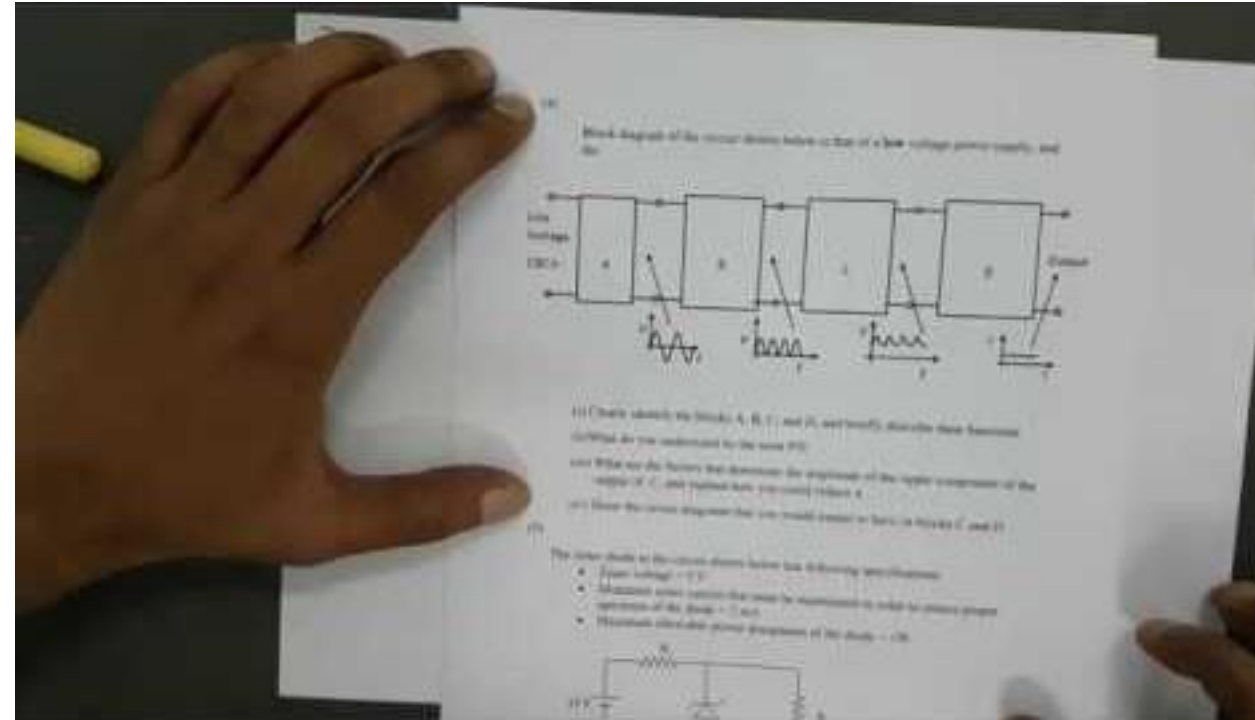

• <https://youtu.be/5KaqHsqdd64?t=580>



100  
1921 - 2021



University of Colombo | Celebrating 100 years of  
excellence in Science

Thank You



- 1. How to arouse interest in especially those "Zoom sleepers"?
- 2. What do you recommend to do when one catches someone who has just switched on the Zoom and gone away?
- 3. Pls speak on different tools to use to make it interactive
- 4. Strategies to reduce screen fatigue in students
- Prof. Dayabandara